

# Influence of load histories on long-term behavior of RC structures

Marija Docevska<sup>1\*</sup>, Goran Markovski<sup>1</sup>, Peter Mark<sup>2</sup>

<sup>1</sup>Ss. Cyril and Methodius University-Skopje, R. Macedonia, Chair of Concrete and Timber Structures

<sup>2</sup>Ruhr-University Bochum, Germany, Institute of Concrete Structures

## Abstract

Creep and shrinkage are important time-dependent phenomena of reinforced concrete (RC) structures. While they usually are negligible with respect to structural reliability, they can strongly affect long-term serviceability and durability due to increasing deflections and crack width with time. Although creep under sustained loads is a relatively well-studied phenomenon, the intensity and frequency of variable loads significantly influences the load history and thus the time-dependent behavior of particular structures like parking garages, bridges or storage buildings. Recently, the quasi-permanent load combination is mostly used for prediction of time-dependent deflections of RC elements caused by variable loads. However, it neither takes into account the actual load history, nor the degradation of element stiffness due to ongoing cracking. Thus, the influence of different load histories on the long-term behavior of flexural RC elements was numerically analysed. Beneath intensity and duration of the variable load, the portion of permanent loads regarding the cracking moment was varied. A numerical step-by-step cross-sectional procedure based on the Age-Adjusted Effective Modulus Method (AAEMM) was applied and successfully verified through existing experimental results. First results confirmed that individual load histories and precisely tracking the stiffness reduction with time, are significant to realistically reflect the long-term behavior of RC elements.

## 1. Introduction

Long-term performance of concrete structures is significantly influenced by time-dependent behavior of concrete, particularly in respect to creep and shrinkage. While they have a little effect on safety of a structure against collapse (with few exceptions including Koror-Babeldaob Bridge in Palau), through progressive increase in deflections and crack widths with time, they can strongly affect its serviceability and durability (Fig.1).

Long-term deflection of reinforced concrete (RC) members involves a complicated interection of many factors, among which creep, shrinkage, cracking and loading history are the most prominent [1]. Underestimation of any of these factors means underestimation of long-term deflections, consequently leading to reduced or disrupted serviceability of a structure (Fig.1).



Fig. 1: Time-dependent deflections of RC slabs and beams at a Garage Parking in Pittsburg (left) and main post-tensioned girders of a bridge in Northern California (right) due to creep and shrinkage

\* docevska.marija@rub.de

Predominantly, time-dependent behavior of concrete structures is related to the action of sustained load coinciding with the permanent load. Nevertheless, the intensity, duration and frequency of variable loads can significantly influence the load history and hence the time-dependent behavior of particular structures like parking garages, bridges and storing buildings.

The influence of different simplified load histories on long-term behavior of flexural RC elements was numerically investigated. In order to demonstrate the sensitivity of long-term deflections to different aspects of load histories, the duration and intensity of the variable load were varied within the same total load. In addition to this, the portion of the permanent loads regarding the cracking moment ( $0.8F_{cr}$  and  $1.2F_{cr}$ ) was also varied. This was done to investigate the influence of the cross-sectional state on the final deflection. For these purposes, a step-by-step cross-sectional procedure based on the Age-Adjusted Effective Modulus (AAEM) method was applied on simply-supported RC flexural members and was successfully verified through existing experimental results elsewhere [2]. The first results indicated that both duration and intensity of the variable load, as well as the permanent-to-cracking load ratio could be of relevance when assessing long-term deflection of RC members under cyclic load pattern.

Although current building codes recognise the concrete phenomenon to creep under variable loads, the influence of different aspects of load histories on long-term behavior has not been explicitly specified.

## 2. Importance of long-term deflection prediction for RC elements due to load histories

The complex and hardly known load history as well as the highly variable concrete long-term properties, represent the main difficulties for predicting the deformations of RC structural members [3]. For reasons of simplicity, code-based approaches to deformation prediction usually neglect the unknown load history, thus, serviceability calculations are based on the sustained load case only, or more precisely, on the quasi-permanent load combination proposed by many current codes, e.g. Eurocode 2 [4].

The quasi-permanent load combination consists of all permanent loads ( $G$ ) and a fraction of live loads (denoted as  $\Psi_2Q$ ), intended to represent their time-average value during the service life. This load combination is independent from the actual load history and it is not able to account for the intermittent high live loads or the preloading at young concrete ages. On one hand, high values of live loads are assumed to be temporary and to have little effect on creep deformations. However, although short-term, these temporary load peaks are sufficiently intense and thus indirectly affect the long-term deflections through permanent reduction of element stiffness. This is also confirmed by analysis of data from Cardington [5,6] suggesting that final deflections are governed by the most severe cracking induced either by possible construction overload or by peak service load [7]. However, it is likely that the quasi-permanent combination will be exceeded during the lifetime of a building and, for the purpose of determining the most severe cracking, the critical load combination should be used.

In addition to the reduced stiffness of the section, cracking also influences the concrete creep and shrinkage deformations since only the uncracked part of concrete is affected by these phenomena. Since the degree of cracking strongly influences the final long-term deflections, these facts indicate that real load histories have to be used instead of quasi-permanent loads. This is particularly true for deflection sensitive structures where serviceability limit states are the governing consideration against ultimate limit states (as structures made of high-strength materials requiring minimum stiffness, long-span bridges, flat RC slabs in multi-story buildings, structural elements with high span-to-depth ratio, etc.).

By step-wise calculation and sufficiently sophisticated models for taking into account the time-dependent concrete effects, it would be possible to analyse the long-term behavior of RC elements with regard to load variations over a period of time. However, this is seldom of any practical interest, since the real variation of the loads during the future service life cannot be predicted due to their randomness [8]. Instead, simplified and idealised expected load histories, as those presented in Fig.2, are suggested to be used in the long-term analysis of the creep sensitive RC structures.

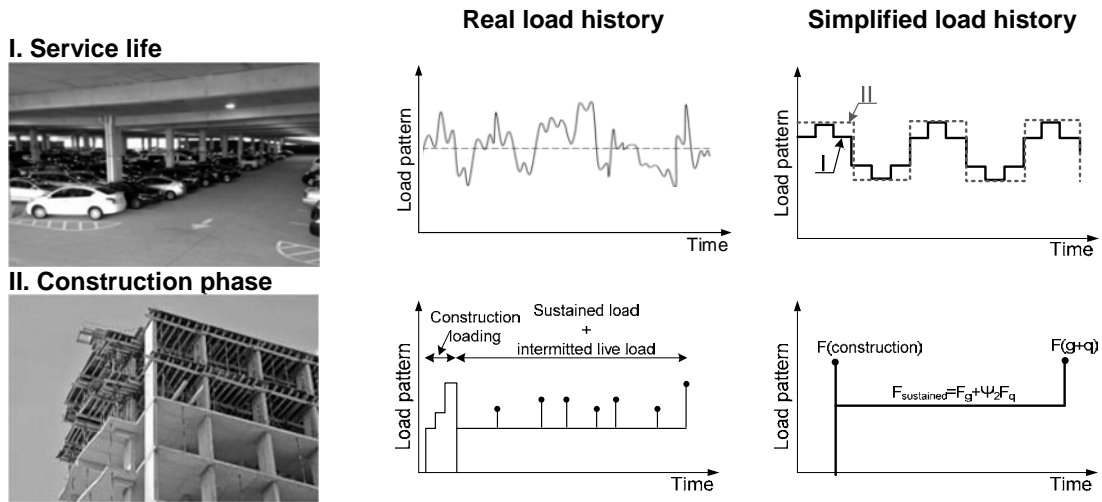

Fig. 2: Real vs. simplified load histories for different types of RC structures during construction and service period

The first effort in modelling the behavior of RC flexural elements under simplified load histories is presented in the following sections of the paper.

### 3. Numerical modeling approach

Numerical analyses for prediction of long-term deflection caused by load histories require application of step-by-step numerical procedures through time discretisation, which is in direct correlation with the considered load history (Fig.3). Subjected to any complex load history, under the assumption of linear behavior (linear creep law for stresses in concrete of less than  $0.45f_c$ ), the total response at any time and at any point of the RC element can be determined by superimposing the individual responses due to the individual load increments (Fig.3) [9].

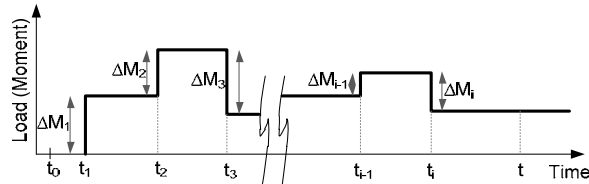

Fig. 3: Time-varying load history

In order to accurately define the effective concrete stiffness and the time-dependent parameters in each time step, it is also necessary to discretise the element relating its cross-sectional height and length. Below, expressions used for prediction of time-dependent local (strains and curvatures) and global (deflections) deformations under time-varying load history are presented.

#### 3.1 Modeling at cross-sectional level

Determination of the long-term deflections of a reinforced-concrete member requires knowledge of strains, stresses and curvature along the member. These quantities are all time-dependent as a result of the combined effect of creep, shrinkage and concrete maturation under a time-varying load. Herein, in each time step, creep coefficients, shrinkage strains and modulus of elasticity of concrete were calculated according to the Model Code 2010 provisions [10].

Based on the principle of superposition, the total curvature can be obtained as the sum of the curvatures caused by load variations (elastic or instantaneous curvature) and the curvatures caused by the time-dependent effects (creep and shrinkage curvature) (Eq. 3.1) [9].

$$k = \sum_i k_{elas.}(t_i) + \sum_i k_{creep}(t, t_i) + k_{shr}(t, t_0) \quad (3.1)$$

The instantaneous curvature (3.2) at a certain concrete age  $t$  can be determined by [9]:

$$k_{elas.} = \frac{A(t)M(t) + B(t)N(t)}{E_c(t)[A(t)I(t) - B(t)^2]} \quad (3.2)$$

Where  $A(t)$ ,  $B(t)$  and  $I(t)$  are the area, the first and the second moment of the transformed cross-section at certain time  $t$ , all taken about the randomly chosen, but constant fibre of the cross-section.

The effects of creep and shrinkage, as well as creep recovery are treated as equivalent fictitious forces that would restrain their deformations. These forces are then applied on the transformed cross-section to determine the time-dependent curvatures  $k_{creep}$ ,  $k_{recovery}$  and  $k_{shr}$ .

The creep-induced curvature  $k_{creep}(t, t_i)$  produced by load increment  $i$  for time interval  $(t, t_i)$  can be evaluated using the Age-Adjusted Effective Modulus (AAEM) method as follows [9]:

$$k_{creep}(t, t_i) = \frac{\overline{A}_e(t, t_i)\Delta M_{creep}(t, t_i) + \overline{B}_e(t, t_i)\Delta N_{creep}(t, t_i)}{\overline{E}_e(t, t_i)[\overline{A}_e(t, t_i)\overline{I}_e(t, t_i) - \overline{B}_e^2(t, t_i)]} \quad (3.3)$$

The age-adjusted effective modulus which account for creep during the time interval  $(t, t_i)$  can be obtained using the Eq.3.4:

$$\overline{E}_e(t, t_i) = \frac{E_c(t_i)}{1 + \chi(t, t_i)\phi(t, t_i)} \quad (3.4)$$

Where  $\chi(t, t_i)$  is the time-dependent concrete aging coefficient, for which a value of 0.8 is mostly assumed;  $\phi(t, t_i)$  is the creep coefficient for the time interval  $(t, t_i)$ ;  $\overline{A}_e(t, t_i)$ ,  $\overline{B}_e(t, t_i)$  and  $\overline{I}_e(t, t_i)$  are the area, the first and the second moment of the age-adjusted transformed cross-section for the time interval  $(t, t_i)$ ; and  $E_c(t_i)$  is the modulus of elasticity of the concrete at age  $t_i$ .

The equivalent moment  $\Delta M_{creep}$  and axial force  $\Delta N_{creep}$  for the creep deformation caused by a load increment at time  $t_i$  can be calculated as [9]:

$$\Delta M_{creep}(t, t_i) = \overline{E}_e(t, t_i)\phi(t, t_i)[A_c(t_i)\varepsilon_{elas.}(t_i) - B_c(t_i)k_{elas.}(t_i)] \quad (3.5)$$

$$\Delta N_{creep}(t, t_i) = \overline{E}_e(t, t_i)\phi(t, t_i)[-B_c(t_i)\varepsilon_{elas.}(t_i) - I_c(t_i)k_{elas.}(t_i)] \quad (3.6)$$

Where  $A_c(t_i)$ ,  $B_c(t_i)$  and  $I_c(t_i)$  are the area, the first and the second moments of the uncracked concrete cross-section (neglecting steel portions), since creep occurs only in the uncracked part of the concrete.

In this study, the creep recovery due to unloading was taken into account in a very simple manner. A load removal was treated as a negative load which would produce creep equal, but opposite to that caused by a positive load of the same intensity. This meant that the same creep functions were employed for both loading and unloading phase, which certainly led to underestimation of the final deflections.

The shrinkage-induced curvature  $k_{shr}(t, t_0)$  can be calculated as [9]:

$$k_{shr}(t, t_0) = \frac{\overline{A}_e(t, t_0)\Delta M_{shr}(t, t_0) + \overline{B}_e(t, t_0)\Delta N_{shr}(t, t_0)}{\overline{E}_e(t, t_0)[\overline{A}_e(t, t_0)\overline{I}_e(t, t_0) - \overline{B}_e^2(t, t_0)]} \quad (3.7)$$

Where  $\overline{A}_e(t, t_0)$ ,  $\overline{B}_e(t, t_0)$  and  $\overline{I}_e(t, t_0)$  are the area, the first and the second moments of the age-adjusted transformed cross-section for time interval  $(t, t_0)$ , respectively, where  $t_0$  is the age of concrete when shrinkage starts to act (in most practical cases, prior to the first loading).

The fictitious moment  $\Delta M_{shr}$  and axial force  $\Delta N_{shr}$  that result from the shrinkage effects in time interval  $(t, t_0)$  are given by [9]:

$$\Delta M_{shr} = \overline{E}_e(t, t_0) \varepsilon_{shr}(t, t_0) B_c(t_0) \quad (3.8)$$

$$\Delta N_{shr} = \overline{E}_e(t, t_0) \varepsilon_{shr}(t, t_0) A_c(t_0) \quad (3.9)$$

Where  $\varepsilon_{shr}(t, t_0)$  describes the shrinkage strain of concrete for time interval  $(t, t_0)$ .

### 3.2 Modeling at member level

The described calculation procedure for the total curvature is repeated for every predefined cross-section along the element and for every time step. Moment-curvature relations can be applied to determine the long-term deflections (Fig.4). The general way is to integrate the total curvatures (instantaneous plus time-dependent) in the predefined cross-sections along the element length, by applying the principles of virtual work and numerical integration [11]:

$$a = \int_0^l k(x) \cdot \overline{M}(x) \cdot dx \quad (3.10)$$

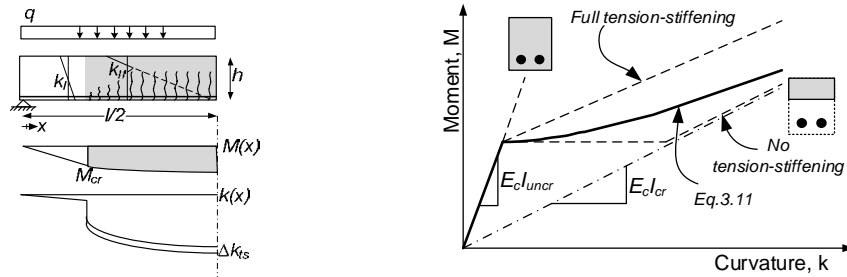

Fig. 4: Schematic illustration of the moment and curvature distribution in a partially cracked beams (left) and moment-curvature relations (right)

When long-term deflections of RC cracked elements are analysed, the procedure for total curvature calculation has to be performed twice, once with uncracked section properties (denoted as curvature  $k_I$  and once assuming a fully cracked section (denoted as curvature  $k_{II}$ ). However, the real behavior of a cracked section will be exhibited between these two scenarios as a result of tension concrete contribution between two adjacent cracks (tension-stiffening effect). This effect cannot be ignored in long-term deflection calculation. Neglecting would overestimate the deformations of the section (fully cracked section), but would underestimate the creep and shrinkage deformations, since only the uncracked part of the concrete is affected by them [12]. Therefore, interpolation between both states is necessary.

Variable stiffness due to cracking, as well as tension-stiffening effect can be considered at section level in many different ways. In this paper, the tension stiffening effect is implicitly incorporated at section level using the mean curvature approach proposed in Eurocode 2 [4] and Model Code 2010 [10] (Eq.3.11).

$$k_m(t) = \beta \cdot (M_{cr}/M_a)^2 \cdot k_I(t) + (1 - \beta \cdot (M_{cr}/M_a)^2) \cdot k_{II}(t) \quad (3.11)$$

Where  $M_{cr}$  is the cracking moment,  $M_a$  is the applied moment and  $\beta$  is the coefficient that takes the load duration into account ( $\beta = 1$  for short-term load and  $\beta = 0.50$  for long-term/repeated load).

#### 4. Verification of the applied model

The procedure described was applied on the RC flexural element shown in Fig.5 to confirm its validity through comparison with the existing experimental results. The presented elements made of ordinary concrete (C30/37) were tested at the Faculty of Civil Engineering in Skopje, R. Macedonia [13] under continuously repeated load with daily scale (Fig.5) in the period of one year. The level of the total load corresponds to the serviceability limit state.

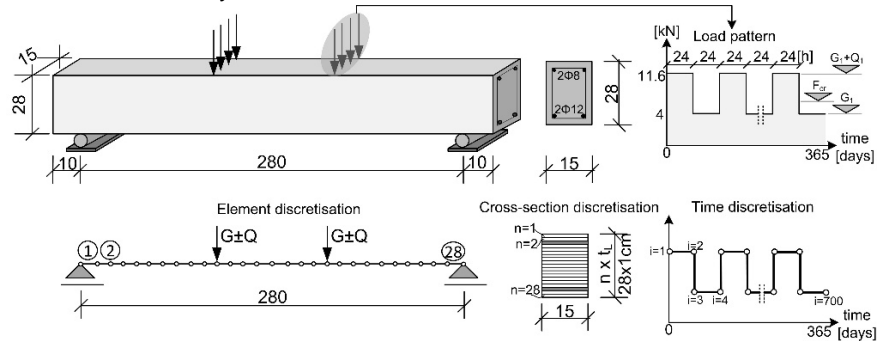

Fig. 5: Geometry, load history of the RC reference elements and their discretisation in the numerical procedure

Table 1 presents the experimentally obtained material properties, applied in further analysis.

Table 1: Concrete and reinforcement experimentally obtained mechanical properties

Property	Concrete (C30/37)			Reinforcement	
	$f_{ck}$ [MPa]	$f_{ct}$ [MPa]	$E_{cm}$ [MPa]	$E_s$ [MPa]	$\sigma_y$ [MPa]
Value	31.90	2.90	30483	200100	400

The beam was discretised into 28 elements along its length and 28 layers were employed over its cross-sectional height to better trace the position of the neutral axis and the change in the cracked portions over time. The time was also discretised into 700 time steps adopting the turning points of the cyclic load pattern (Fig.5). The applied step-by-step technique required a large amount of input parameters and separate storing of concrete stresses and strains in each time step. For these purposes, MATLAB software was used.

The applied numerical procedure consists of multiple, aligned short-term and long-term analyses. The most characteristic steps are presented in Fig.6.

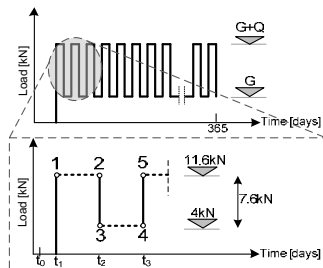

Fig. 6: Characteristic steps in the applied numerical procedure

1. **Short-term analysis** + shrinkage effect ( $F=G+Q=11.6kN$ )
2. **Long-term analysis** – creep effects for time interval ( $t_1, t_2$ ) + shrinkage effect ( $F=G+Q=11.6kN$ )
3. **Short-term analysis** – instantaneous recovered deflection due to unloading at time  $t_2$  ( $F=Q=7.6kN$ )
4. **Long-term analysis** – creep effects ( $F=G=4kN$ ) + creep recovery at time interval ( $t_2, t_3$ ) ( $F=Q=7.6kN$ ) + shrinkage effects
5. **Short-term analysis** ( $F=G+Q=11.6kN$ )

As mentioned, long-term deflections caused by variable repeated loads can be analysed either by using the step-by-step method (to account for the load history) or by using the code-based procedure with quasi-permanent loads. Fig. 7 presents the development of the calculated long-term deflections in time obtained by use of both approaches, namely, cyclic load history and quasi-permanent load

combination with experimentally established value for the coefficient  $\psi_2 = 0.50$ . The results in both cases show a trend of underestimation of the deflections with time. Generally, they are in good agreement with the experimental data.

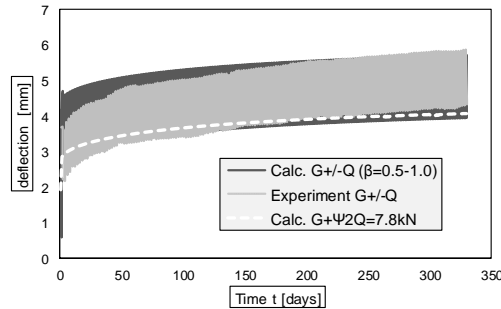

Fig. 7: Comparison between experimental data and numerical results for long-term deflections along time

A possible explanation for the underestimation trend of the predicted deflection is the fact that the effect of creep recovery is overestimated in the calculation which consequently leads to underestimation of the irrecoverable part of the deflection. Thus, additional experimental and theoretical investigations for creep functions after partial unloading are necessary in order to enhance the current numerical model. Also, the challenge regarding the influence of cracking on the irreversible part of creep and the irreversible part of instantaneous deflection after unloading still remains.

## 5. Results and discussion

The calculation procedure was applied to study the time-dependent behavior of RC elements (Fig.5) under various load histories. Namely, six different load histories were analysed. Each of them consisted of continuously repeated loading and partial unloading cycles (Fig.8). The variable load amplitude was constant over the whole loading process and the unloading was always at a permanent load level. Regarding the level of the permanent load in terms of the cracking load, the analysed load histories were generally divided into two main groups. The two investigated portions of the permanent load corresponded to  $0.8F_{cr}$  (Group I) and  $1.20F_{cr}$  (Group II) ( $F_{cr}$  is the load causing the first crack), while the total amount of the load remained equal in both groups. The total permanent plus variable load corresponded to the serviceability load, or more precisely to 55% with respect to the ultimate load ( $0.55F_u$ ). In addition, in each of both groups, different time histories were considered, namely, 16h under total load and 8h under permanent load only ( $\Delta t_G=8h/\Delta t_{G+Q}=16h$ ), then  $\Delta t_G=24h/\Delta t_{G+Q}=24h$  and finally  $\Delta t_G=48h/\Delta t_{G+Q}=48h$ . The durations of the loading and unloading cycles were chosen to represent the real duration of the live loads on specific types of RC structures (for example, city bridges, warehouses, parking garages, etc.).

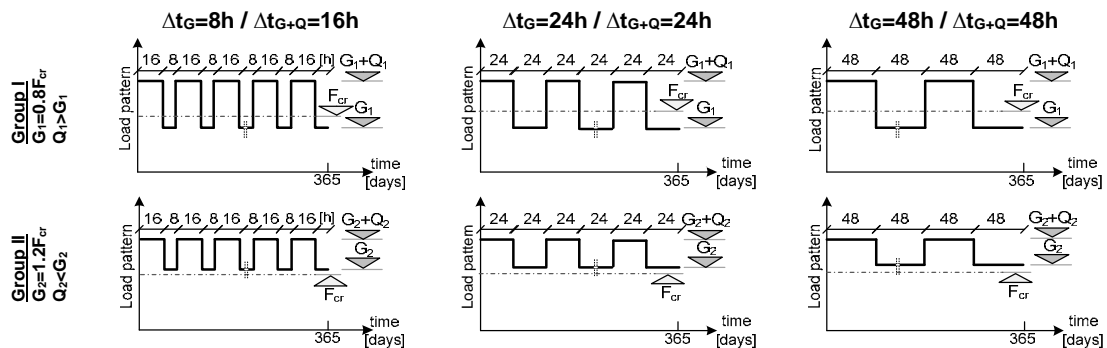

Fig. 8: Analysed load histories

Figs. 9, 10 and 11 show the long-term deflections (denoted as I) caused by the load histories presented in Fig.8 for a period of one year. For the purpose of comparison, long-term deflections caused only by the permanent load G (denoted as II) are additionally presented on the same diagram. Due to the concrete phenomenon to creep under repeated variable loads, the final long-term deflections caused by load histories are certainly much higher than those caused by permanent load only. A great part of these differences occurs due to the irreversibility of the deflections appeared even after the first unloading cycle. This irreversibility arises from the permanent reduction of element stiffness due to the development of cracks under the total amount of load. Such differences are slightly less pronounced in the second case (Group II), where the chosen level of permanent load within the load history is above the cracking load level. This confirmed again the influence of the degree of cracking on the development and final values of the element's long-term deflections.

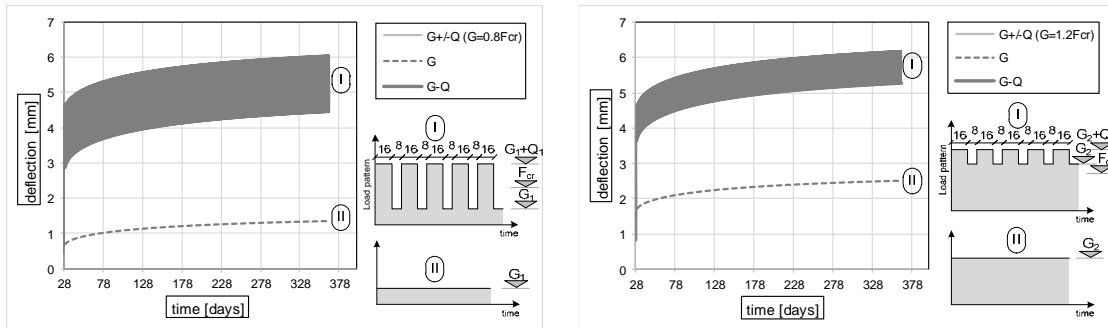

Fig. 9 Long-term deflections caused by the load history  $\Delta t_G/\Delta t_{G+Q}=8h/16h$  (I) and the permanent load only (II) for Group I (left) and Group II (right)

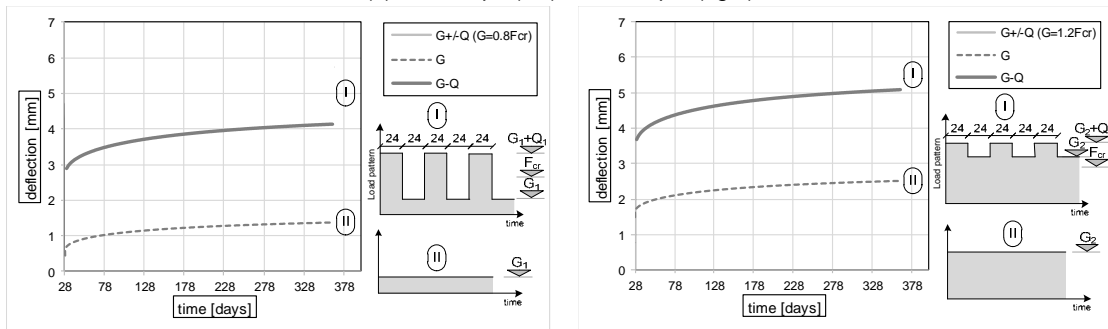

Fig. 10 Long-term deflections caused by the load history  $\Delta t_G/\Delta t_{G+Q}=24h/24h$  (I) and the permanent load only (II) for Group I (left) and Group II (right)

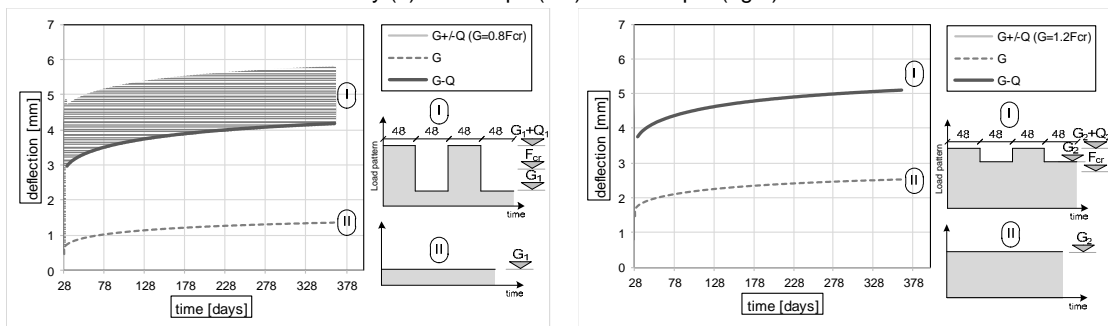

Fig. 11 Long-term deflections caused by the load history  $\Delta t_G/\Delta t_{G+Q}=48h/48h$  (I) and the permanent load only (II) for Group I (left) and Group II (right)

Fig.12 presents the influence of different duration of loading/unloading cycles on long-term deflections expressed through normalized deflections  $a/a_{max}$ . It can be noticed that, under equal total time of loading and partial unloading (in this case 24h/24h and 48h/48h), the differences in long-term



deflections are minor (0.5%-Group I and 0.4%-Group II), which is not the case when the total time under loading differs from the time under unloading (in this case 16h/8h). The long-term deflections under this load history (16h/8h) are 8.7% (Group I) and 3.95% (Group II) higher than those caused by the load histories with equal total duration of the loading and unloading phase (24h/24h and 48h/48h). This analysis of the results suggests that the participation of the variable load duration in the load histories may differently influence the long-term deflections, although these effects are relatively small for the considered load histories.

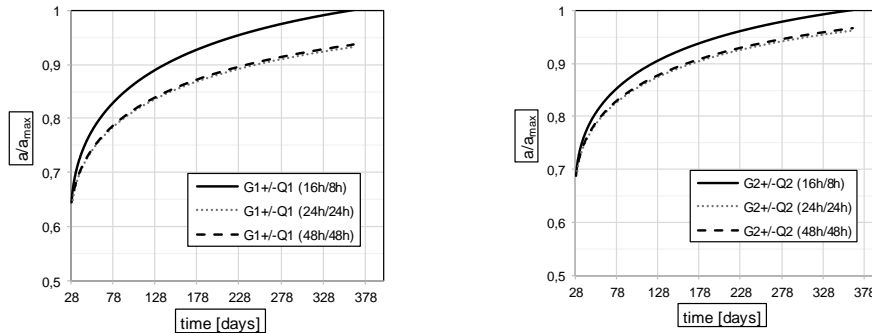

Fig.12 Comparison between time-dependent normalized deflections caused by load histories form Group I (left) and Group II (right) for different duration of loading/unloading cycles

Fig.13 shows the influence of the permanent-to-cracking load ratio on the long-term deflections for each time duration of loading/unloading cycles (16h/8h, 24h/24h и 48h/48h). The same figure also shows the effects of the variable load intensity on the long-term deflections within the same total load. Despite the same total load, the results show that load histories from Group II produce greater deflections than those from Group I. Having in mind the simultaneous action of creep under the permanent load and creep recovery under the variable load within the unloading phase, the long-term deflections caused by Group II are unsurprisingly greater, since the permanent load is higher ( $F_{G2} > F_{G1}$ ) and the variable load is lower ( $F_{Q2} < F_{Q1}$ ) than those from Group I. Another possible reason for these differences lies in the higher irreversible deflection after the first unloading cycle, since the variable load has a lower value in the load histories of Group II.

The differences between the long-term deflections as a result of different permanent-to-cracking load ratio vary among 15.5%-18.17% for all three cases, meaning that the distribution of the total load within the permanent and variable load is sufficient for long-term final deflections. These differences are more pronounced than those arising from different duration of loading/unloading cycles. Regarding the considered simplified load histories, this points to higher sensitivity of long-term deflections to intensity than to duration of the variable load.

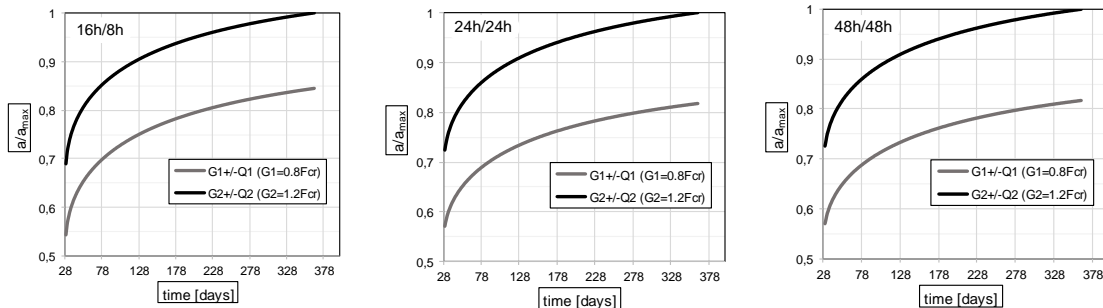

Fig. 13 Comparison between long-term normalized deflections due to load histories from Group I (grey) and Group II (black) for all considered time histories: 16h/8h (left), 24h/24h (middle) and 48h/48h (right)

Besides the load histories specific for the structure's service life, significant load histories can also arise during its construction period. They can result from shoring and reshoring procedures in multi-

story construction, as well as due to a temporary storage of construction materials and equipment (drywall, reinforcement bars etc.) [1]. The importance of such histories will be demonstrated here through two, or more precisely, four specific and simplified load histories (denoted as “A1”, “A2”, “B1” and “B2”). As shown in Fig.14, the full value of dead plus live load is applied at concrete age of 28 days in the load histories “A1” and “B1” to simulate a typical preloading during the construction period. The construction load is followed by the sustained quasi-permanent load for the period of one year and then a remained live load is applied to simulate a frequent load combination.

The main difference between these two load histories is the level of the quasi-permanent load regarding the cracking load. To demonstrate the influence of the loading during and after the construction period, two additional histories were parallelly analysed, namely load history “A2” and “B2” (Fig.14). As it can be noticed from Fig.14, they omitted the preloading during the construction and consisted of sustained quasi-permanent load only, followed by remained live load. In structural design practice, load histories “A2” and “B2” are typically used for predicting long-term deflections.

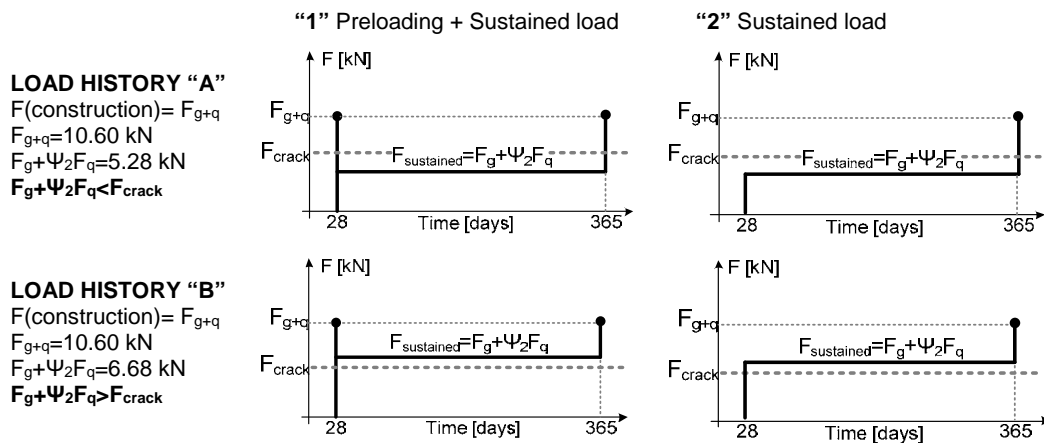

Fig. 14 Analysed load histories during and after the construction period

Comparison between long-term deflections due to load histories “A1” and “A2” (left), as well as “B1” and “B2” (right) is shown in Fig.15. It is clear from these comparisons that the development of long-term deflections is underestimated when construction load is omitted in the deflection calculation. This is particularly emphasized when the level of the sustained quasi-permanent load is below the level of the cracking load (Load history “A2”). Namely, long-term deflections computed with respect to the load history “A2” is for 54% lower than those computed with the load history “A1”. This difference occurs less pronounced when compared long-term deflections due to load histories “B1” and “B2” (15.2%).

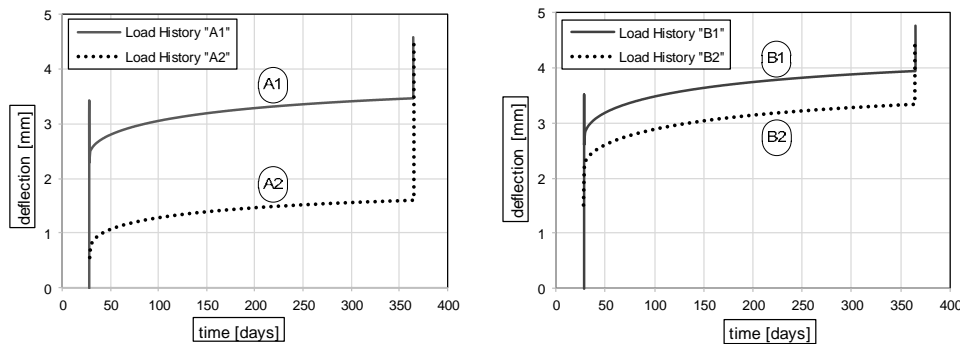

Fig.15 Comparison between long-term deflections due to load histories “A1”/“A2” (left) and “B1”/“B2” (right)

The analysis of the results suggests that the construction loads which can reach the specified design load, can have a significant effects on the extend of cracking in the member prior to service load. Undoubtedly, this leads to higher long-term deflections under the action of sustained loads and should be appropriately accounted for in serviceability analysis of RC flexural members.

## 6. Conclusions

The time-dependent behavior of RC flexural elements has been numerically investigated under various load histories. Within the same total load, intensity and duration of the variable load were varied, as well as the portion of the permanent load regarding the cracking load. Based on the current results from the numerical modeling, the following conclusions are drawn:

- Analysis of the computed long-term deflections caused by load histories from Group I ( $F_{G1}=0.8F_{cr}$ ;  $F_{Q1}$ ) and Group II ( $F_{G2}=1.2F_{cr}$ ;  $F_{Q2}$ ) has shown that the permanent-to-cracking load ratio ( $F_G/F_{cr}$ ), as well as the variable load intensity have a considerable influence on their development. For the chosen load histories, these differences are in the range of about 15 to 18%. A higher irreversible deflection from the load histories from Group II is one of the reason for these differences, since variable load in this group has a lower value (a load which produce recovering of the instantaneous deflection after its removal). Another important aspect which additionally contributes to a higher final deflection results is bigger long-term effects during the unloading phase. A lower variable load as well as a higher permanent load in the load histories from Group II resulted in higher long-term deformations due to the simultaneous action of the two time-dependent deformations: creep and creep recovery.

- The time-dependent behavior of RC elements depends on the ratio between the duration of loading and unloading cycles. For the considered durations of the variable load, results have shown that while the differences between long-term deflections under the same duration of loading and unloading cycles ( $\Delta t_G/\Delta t_{G+Q}=24h/24h$  and  $\Delta t_G/\Delta t_{G+Q}=48h/48h$ ) are minor, they are among 4% and 9% in the cases where these durations are different ( $\Delta t_G/\Delta t_{G+Q}=8h/16h$ ). This analysis of the results suggests that the participation of the variable load duration in the load histories influences the element final deflections, although this effect is relatively small comparing with the differences due to the variation of the permanent and variable load intensity.

- The quasi-permanent approach has been proven useful and has been accepted in many current codes, mostly due to its simplicity. However, having in mind the interrelation between the cracking extend and the final long-term deflection, it is apparent that this simplified approach will yield inaccurate results in some special cases. This is particularly true when the quasi-permanent level is below the cracking level or when the load history is complex consisting of high live load peaks. This can be also concluded from the presented results in the paper. Therefore, as a solution for this issue, it is suggested that expected or rather real load histories should be used for deflection prediction in order to determine the most unfavorable crack pattern.

## Literature

- [1] Scanlon, A.; Bischoff, P. H.: Shrinkage restraint and loading history effects on deflections of flexural members. ACI Structural Journal, V. 105, No. 4, July-August 2008, pp.498-506
- [2] Aranjelovski, T., Markovski, G., Mark, P.: Influence of repeated variable load on long-term behavior of concrete elements. Journal of Civil Engineering and Architecture, ISSN 1934-7359, USA, Volume 8, No.3, pp. 302-314, 2014
- [3] Burns, C.: Serviceability analysis of RC based on the tension chord model. Doctoral dissertation, ETH Zurich, 2011
- [4] EN 1992-1-1: Design of Concrete Structures - Part 1-1: General Rules and Rules for Buildings, 2004.
- [5] Hossain, T.R.; Vollum, R.L.: Prediction of slab deflections and validations against Cardington data. Proc. Of the Inst. Of Civil Eng., Structures and Buildings, No. 152, 2002, pp.235-248.
- [6] Vollum, R.L.; Moss, R.M.; Hossain, T.R.: Slab deflection in the Cardington in-situ concrete frame building. Magazine of Concrete Research, No.54, 2002, pp.23-24
- [7] The Concrete Society: Deflection in concrete slabs and beams. Concrete Society Technical Report No.58, 2005

- [8] Westerberg. B.: Time-dependent effects in the analysis and design of slender concrete compression members. Doctoral dissertation, Stockholm, 2008
- [9] Khor, E.H.; Rosowsky, D.V.; Stewart, M.G.: Probabilistic analysis of time-dependent deflections of RC flexural members. Computers and Structures, No. 79, 2001, pp.1461-1472
- [10] International Federation of Structural Concrete (fib): fib Model Code for Concrete Structures 2010. Ernst & Sohn, 2013
- [11] Docevska, M.; Heek, P.; Markovski, G.; Mark, P.: Fibre modelling of RC elements subject to time-variant mechanical and thermal actions. In: Proc. of the 2016 Symposium of ASES, Serbia, 2016, pp. 173-183
- [12] Criel P, Caspeelee R, Matthys S, Taerwe L. Creep experiments and analysis of T-shaped beams subjected to loading and unloading at young age. In: Furuta H, Frangopol DM, Akiyama M, editors. Life-Cycle of Structural Systems : Design, Assessment, Maintenance and Management, Proceedings. Leiden, The Netherlands: CRC Press; 2014. p. 2186–92.
- [13] Aranjelovski, T.: Time-dependent behavior of reinforced high-strength concrete element under action of variable loads. Doctoral dissertation, Skopje, 2011